

ME-02 Offshore Swing Door Latch

Mortise locking

Features

- All marine-grade materials for corrosion resistance
- Mortise mount installation
- Interior privacy lock with exterior override

Material

- Lock engine: Aluminum
- Handles, escutcheons finish: Chrome, aluminum and black
- Privacy: Acetal



Mortise Privacy Locking

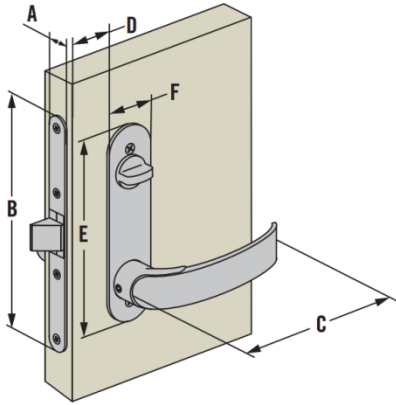

	Imperial		Metric
	Nominal	Decimal	
A	31/64	.492	12.5
B	5 5/16	5.31	135
C	3 15/16	3.94	100
D	39/64	.61	15.5
E	4 37/64	4.59	116
F	1 3/16	1.18	30

Panel Preparation

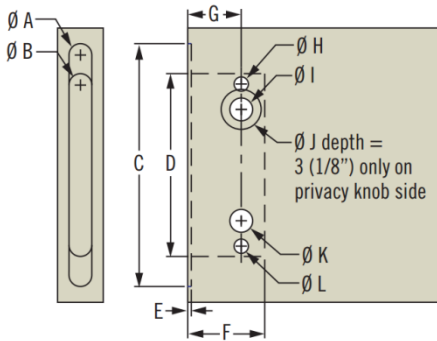

Strikers sold separately.
Contact Gripwell for details

	Imperial		Metric
	Nominal	Decimal	
A	1/2	.50	12.5
B	1/2	.50	12.5
C	5 5/16	5.31	135
D	4	4	102
E	1/16	.06	1.5
F	1 11/16	1.69	43
G	1 11/64	1.17	30
H	5/16	.31	8
I	1/2	.50	12
J	7/8	.88	22
K	1/2	.50	12
L	5/16	.31	8

ME - 02 - **D** **L** **T** - **FF**

D Directional

- 2 Right Out
- 3 Right In
- 4 Left Out
- 5 Left In

L Locking Option

- 0 Privacy
- 1 Key Locking

FF Finish

- 10 Chrome
- 50 Black
- 60 Aluminum

T Door Thickness

- 4 18-22mm (11/16" - 7/8")
- 5 22-27mm (7/8" - 1 1/16")
- 6 27-32mm (1 1/6" - 1 1/4")
- 7 32-37mm (1 1/4" - 1 1/2")

D Directional Door Swing:

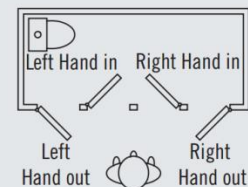

southco®

We are proud to be Southco's authorized distributor of over 20 years

MC Striker

Features

- Available in seven different sizes
- Suitable for Offshore, McCoy, Compact, and Omni swing door latches and many door and frame configurations and door thicknesses
- Striker tongue prevents wear from boat vibration
- Optional dustbin hides sawdust in the cut out hole and provides an elegant finish to the frame edge

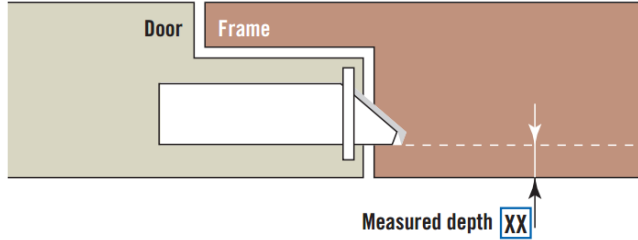
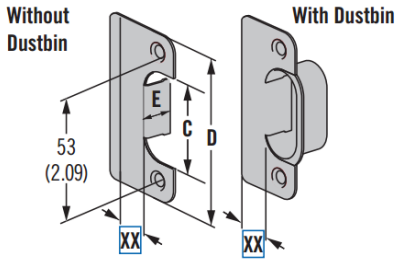

To find the right striker for your application, measure the distance from the door face to the edge of the springbolt of the latch.

C		D		E	
Metric	Imperial	Metric	Imperial	Metric	Imperial
36	1 7/16	68	2 11/16	13	1/2

MC - 90 - Z XX - FF

Z Dustbin Option
 1 No Dustbin
 2 With Dustbin

XX Position
 03 3mm (7/64")
 05 5mm (3/16")
 07 7mm (1/4")
 09 9mm (3/8")
 13 13mm (1/2")
 16 16mm (5/8")
 21 21mm (7/8")

FF Finish
 10 Brass, nickel plated
 24 Stainless steel
 40 Brass

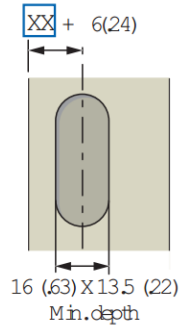

MC Whale Striker

Features

- Suitable for Offshore, McCoy and Compact swing door latches
- Quick and easy installation

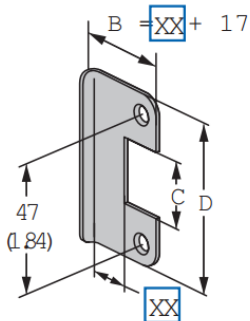

MC - 90 - 3 - XX - FF

XX Position
 03 3mm (7/64")
 05 5mm (3/16")
 07 7mm (1/4")
 09 9mm (3/8")
 13 13mm (1/2")
 16 16mm (5/8")
 21 21mm (7/8")

FF Finish
 10 Brass, nickel plated
 40 Brass

C		D	
Metric	Imperial	Metric	Imperial
60	2 3/8	22	7/8